

# User Manual

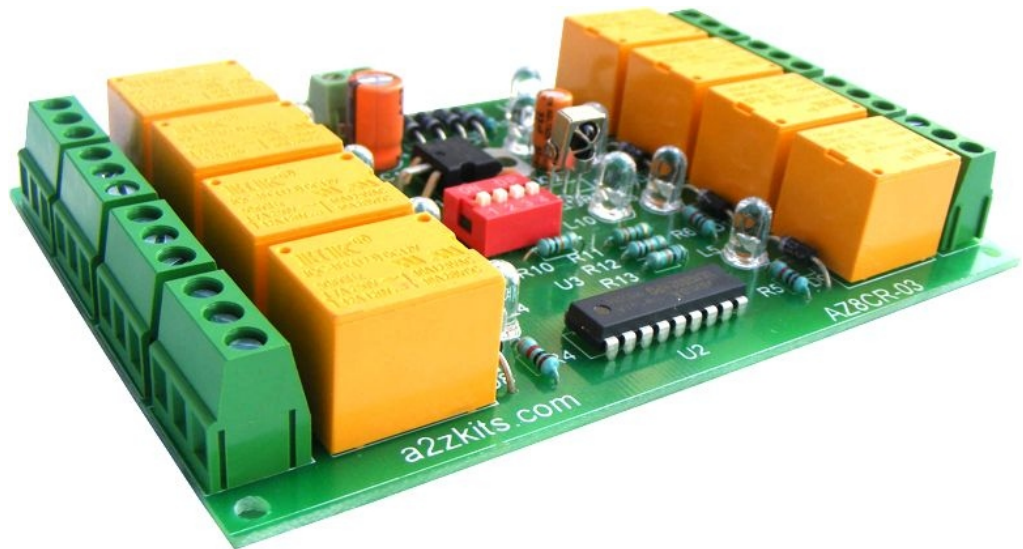

### Specifications -

Transmitter - IR Transmitter handset is common for all the receiver kits.  
Based on Rc5 Philips coding.

Requires 2 AAA battery.

Receiver - Outputs - 4 relays for az4cr-03  
- 6 relays for az6cr-03  
- 8 relays for az8cr-03  
- 12 relays for az12cr-03

Input supply - 9 V AC or 12 V DC

Relay contact rating - 5 amp at 230 V AC.

### Features -

- Based on latest microcontroller.
- Eight relay outputs for different kind of requirement.
- potentially free NO & NC contact outputs
- Momentary & Toggle mode selectable by DIP switch.
- Long range
- Easy to add remote control facility to many projects
- Visual LED indication for correct IR signal reception.
- Visual LED indication for each Relay.
- Small & Compact size.

### Can be used for -

- Switching lights & fans on & off at homes, offices, shops, hotels by remote.
- Switching motors on & off.
- Converting machines & equipments to be operated by IR remote.
- Replacing switches with IR remote.

Want something different ? More outputs ? Special requirements ?

Different configuration ? Just let us know at [support@iknowvations.in](mailto:support@iknowvations.in).

We will provide you solutions as per your requirements. After all our more than 20 years experience helps .

# Remote Control Relay Board-AZ8CR-03

User manual

## Making of Remote light switches using IR control relay boards azxcr-03

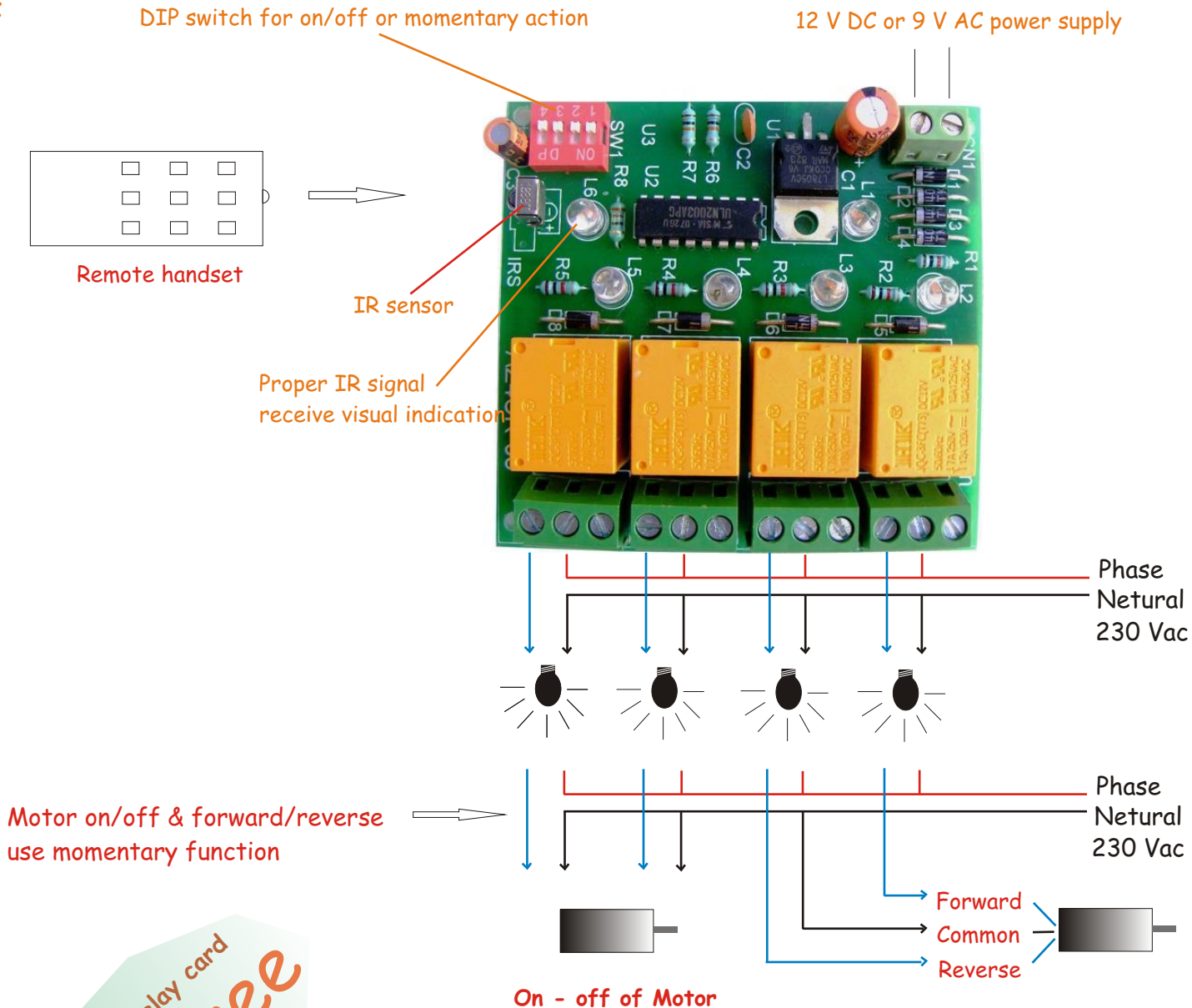

Motor on/off & forward/reverse use momentary function



There are many more varied uses of our Infrared controlled relay boards. Send us your novel idea to us at [info@iknowvations.in](mailto:info@iknowvations.in) & you can have a chance to win a free Infrared controlled relay card.

If you have any questions, want any assistance, want us to develop any special products for you just contact us at [support@iknowvations.in](mailto:support@iknowvations.in).

We have other products also that might interest you like -

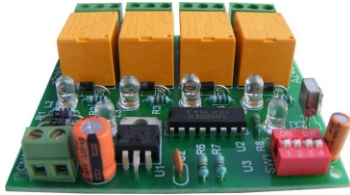

4 channel IR Remote control Board - AZ4CR-03

6 channel IR Remote control Board - AZ6CR-03

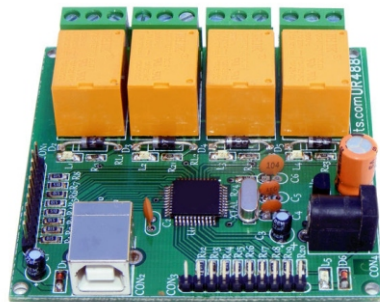
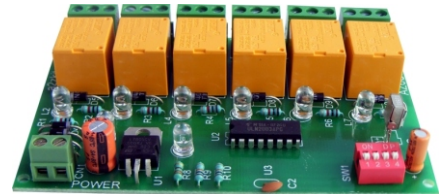

U452 is an USB based Relay Card having up to 16 I/O channels & 8 ADC channels. The ADC resolution is 8/10/12 bits user selectable.

R242 is an RS232 based Relay Card having up to 9 I/O channels & 4 ADC channels. The ADC resolution is 10 bits.

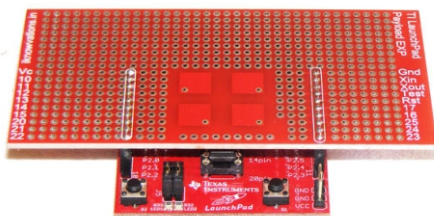
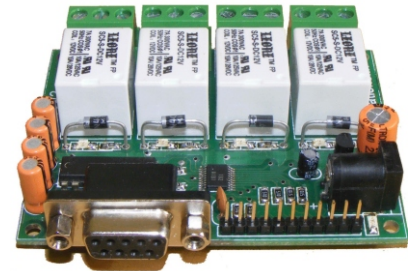

Experimental Board for TI LaunchPad.

6 digit 7 segment Multipurpose LED Counter

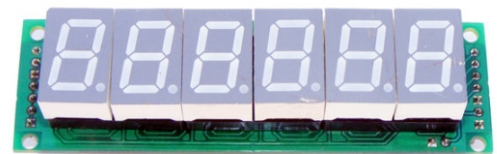

For more information visit - [www.iknowvations.in](http://www.iknowvations.in)

For experiments & other technical knowledge do read our blog at [www.iknowvations.in/blog/](http://www.iknowvations.in/blog/)



### Please Read Carefully

Information in this document is provided solely in connection with Iknowvations products. Iknowvations reserve the right to make changes, corrections, modifications or improvements, to this document, and the products and services described herein at anytime, without notice.

All Iknowvations products are sold pursuant to Iknowvations terms and conditions of sale.

Purchasers are solely responsible for the choice, selection and use of the Iknowvations products and services described herein, and Iknowvations assumes no liability whatsoever relating to the choice, selection or use of the Iknowvations products and services described herein.

No license, express or implied, by estoppel or otherwise, to any intellectual property rights is granted under this document. If any part of this document refers to any third party products or services it shall not be deemed a license grant by Iknowvations for the use of such third party products or services, or any intellectual property contained therein or considered as a warranty covering the use in any manner whatsoever of such third party products or services or any intellectual property contained therein.

**UNLESS OTHERWISE SET FORTH IN IKNOWVATIONS'S TERMS AND CONDITIONS OF SALE IKNOWVATIONS DISCLAIMS ANY EXPRESS OR IMPLIED WARRANTY WITH RESPECT TO THE USE AND/OR SALE OF IKNOWVATIONS PRODUCTS INCLUDING WITHOUT LIMITATION IMPLIED WARRANTIES OF MERCHANTABILITY, FITNESS FOR A PARTICULAR PURPOSE (AND THEIR EQUIVALENTS UNDER THE LAWS OF ANY JURISDICTION), OR INFRINGEMENT OF ANY PATENT, COPYRIGHT OR OTHER INTELLECTUAL PROPERTY RIGHT.**

**UNLESS EXPRESSLY APPROVED IN WRITING IKNOWVATIONS PRODUCTS ARE NOT RECOMMENDED, AUTHORIZED OR WARRANTED FOR USE IN MILITARY, AIR CRAFT, SPACE, LIFE SAVING, OR LIFE SUSTAINING APPLICATIONS, NOR IN PRODUCTS OR SYSTEMS WHERE FAILURE OR MALFUNCTION MAY RESULT IN PERSONAL INJURY, DEATH, OR SEVERE PROPERTY OR ENVIRONMENTAL DAMAGE.**

Resale of IKNOWVATIONS products with provisions different from the statements and/or technical features set forth in this document shall immediately void any warranty granted by Iknowvations for the Iknowvations product or service described herein and shall not create or extend in any manner whatsoever, any liability of Iknowvations.

Information in this document supersedes and replaces all information previously supplied.

The Iknowvations logo is property of Iknowvations.in. All other names are the property of their respective owners.

© 2012 Iknowvations - All rights reserved

[www.iknowvations.in](http://www.iknowvations.in)

Manufactured by -

Iknowvations  
Rajivnagar, Vidyanagar  
Hubli - 580021  
India.