

User Manual : iR-8C-V

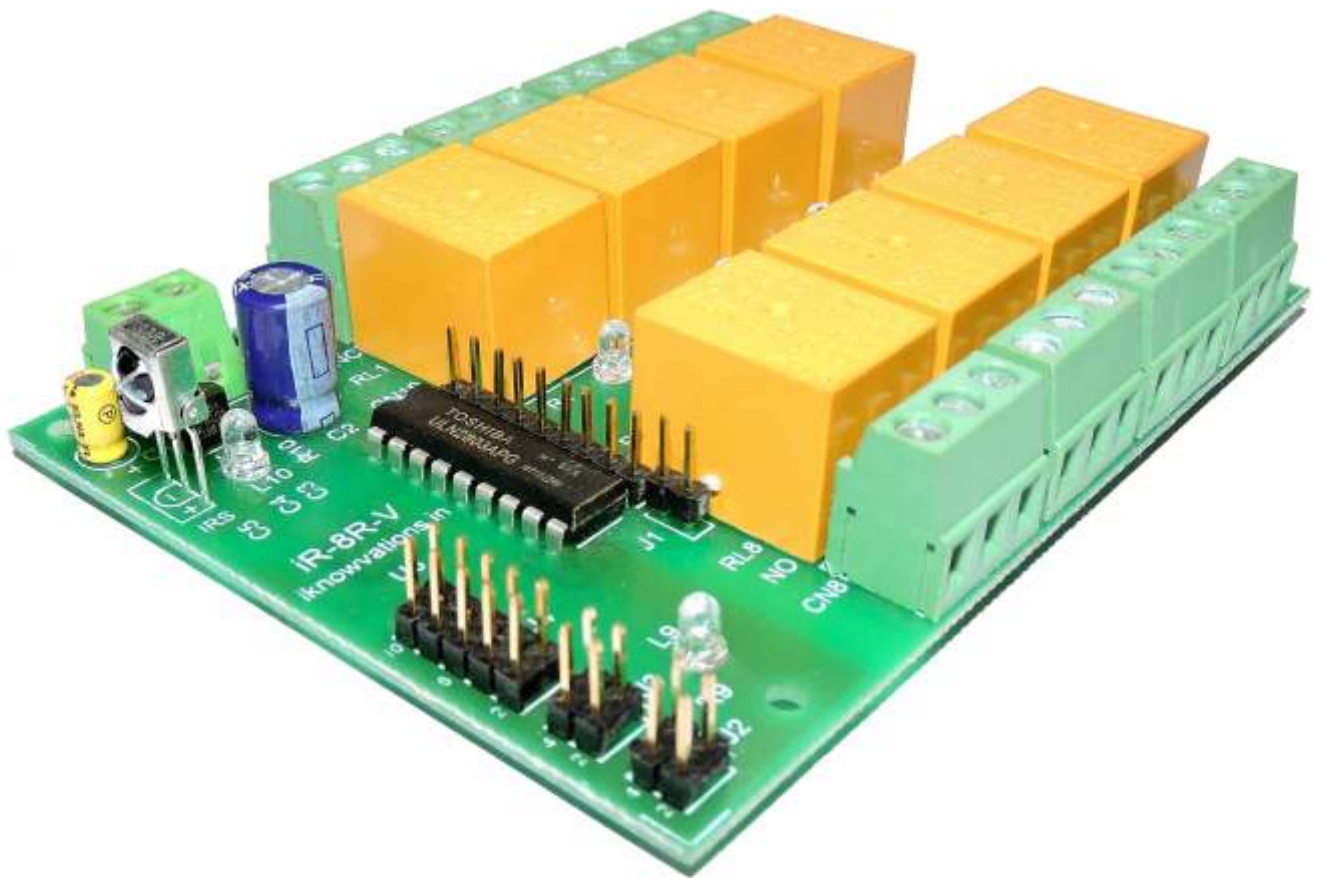

iR-8R-V detail

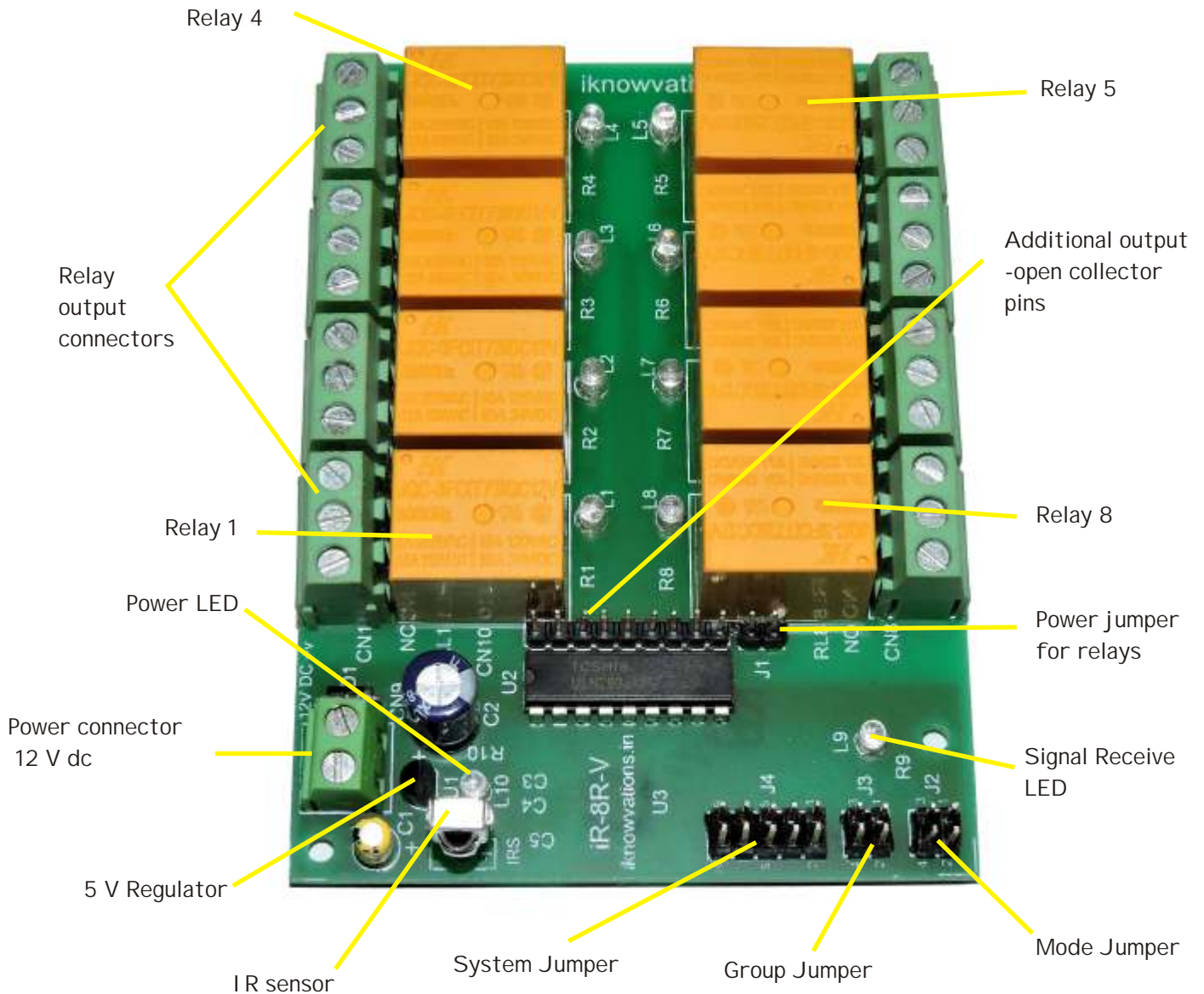

Remote handset detail

Default Option

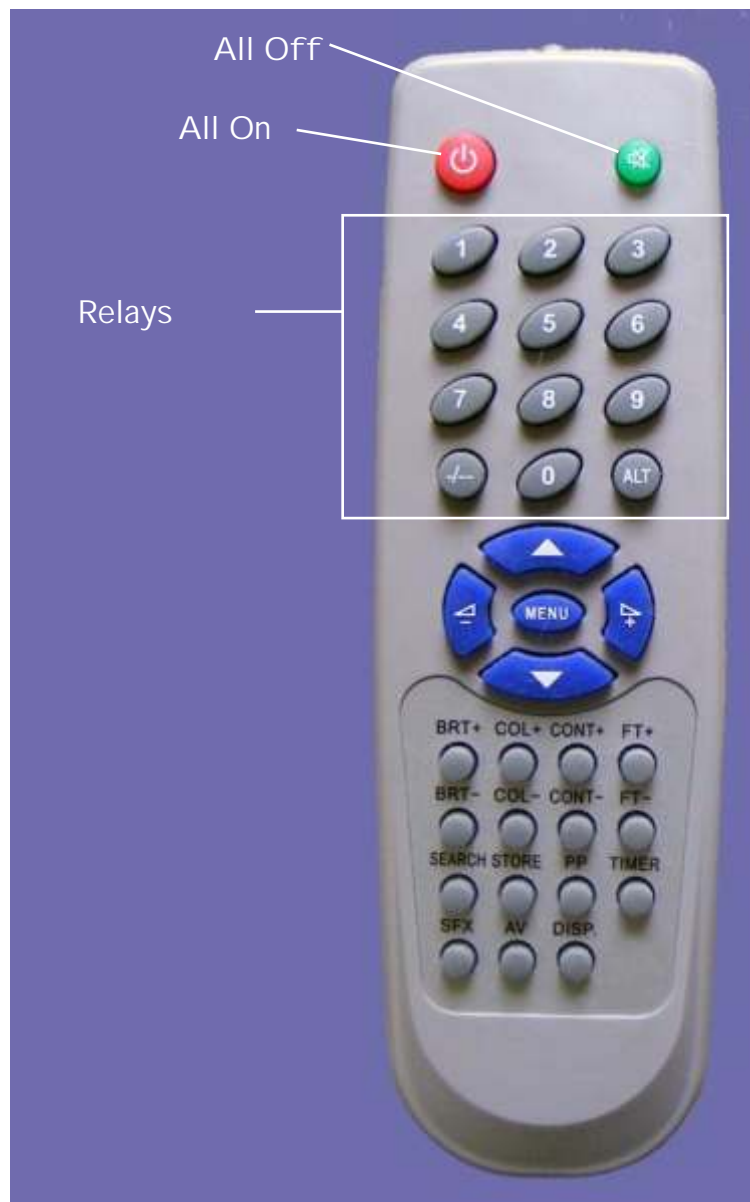

This is default option.



Specifications -

- Transmitter - I R Transmitter handset is common for all the receiver kits.
Based on RC5 Philips coding.
Requires 2 AAA battery.
- Receiver - Outputs - 8 relays for iR-8R-V
Input supply - 12 V DC
Relay contact rating - 5 amp at 230 V AC.

Features -

- Based on latest microcontroller.
- System & Address codes programmable.
- Twelve relay outputs for different kind of requirement.
- Potentially free NO & NC contact outputs.
- Momentary & Toggle mode selectable..
- All On & All Off facility.
- Long range
- Easy to add remote control facility to many projects
- Visual LED indication for correct I R signal reception.
- Visual LED indication for each Relay.
- Visual LED indication for power.
- Small & Compact size.

Can be used for -

- Switching lights & fans on & off at homes, offices, shops, hotels etc. by I R remote.
- Switching motors on & off.
- Converting machines & equipments to be operated by I R remote.
- Replacing switches with I R remote.

Want something different ? More outputs ? Special requirements ?

Different configuration ? Just let us know at support@iknowvations.in.

We will provide you solutions as per your requirements. After all our more than 20 years experience helps .

Programming of system codes.

This IR relay board uses Philips RC5 coding system for communication. RC5 codes contain 5 bits of system code & 6 bits of command code. This helps to differentiate each board with other, so that only one board will respond to a particular command. This way you can control $32 * 4 = 128$ different boards, that is $128 * 8 = 1024$ total relays without interfering each other.

Now let us see how this can be achieved. Following picture shows the detail of Jumper J2.

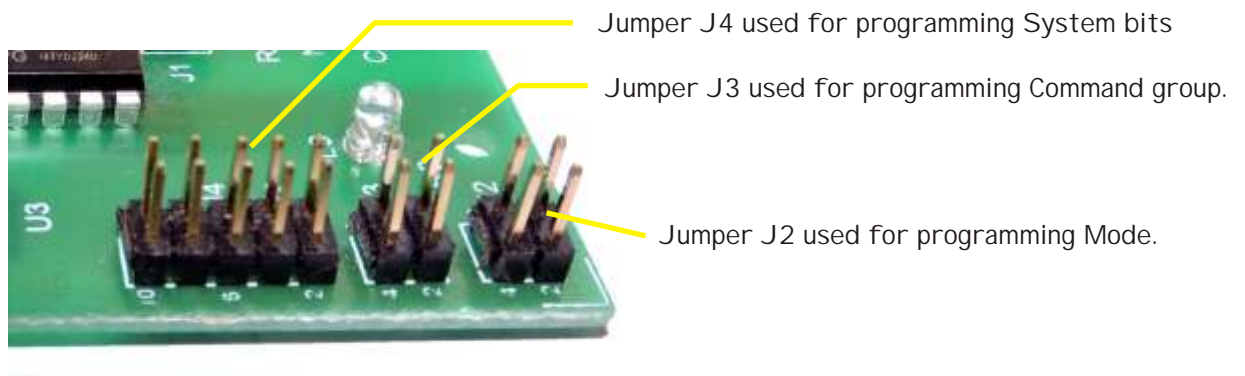

Pins 1 & 2, 3 & 4, 5 & 6, 7 & 8, 9 & 10 of Jumper J4 can be connected (ON) or left open (OFF) to program the system code.

Same way pins 1 & 2 and 3 & 4 of Jumper J3 can be connected or left open to program command group.

Pins of Jumper J2 is used for making group of relays to operate in Toggle Mode or Momentary mode.

In Toggle mode, a relay can be made ON by pressing button on Remote handset or sending relevant code once. Again sending the same code or again pressing the same button will make that relay OFF.

While in Momentary mode, the relay will be ON till button on remote handset is kept pressed or relevant code is continuously sent. The relay will be OFF as soon as button is released or sending of command is stopped.

The details of jumper setting is shown in next page.



Following table shows the System bits as per different jumper J4 settings.

Jumper J4 settings					System bits					Hex value	Decimal value
Pins 9&10	Pins 7&8	Pins 5&6	Pins 3&4	Pins 1&2	4	3	2	1	0		
Off	Off	Off	Off	Off	0	0	0	0	0	0	0
Off	Off	Off	Off	On	0	0	0	0	1	1	1
Off	Off	Off	On	Off	0	0	0	1	0	2	2
Off	Off	Off	On	On	0	0	0	1	1	3	3
Off	Off	On	Off	Off	0	0	1	0	0	4	4
Off	Off	On	Off	On	0	0	1	0	1	5	5
Off	Off	On	On	Off	0	0	1	1	0	6	6
Off	Off	On	On	On	0	0	1	1	1	7	7
Off	On	Off	Off	Off	0	1	0	0	0	8	8
Off	On	Off	Off	On	0	1	0	0	1	9	9
Off	On	Off	On	Off	0	1	0	1	0	A	10
Off	On	Off	On	On	0	1	0	1	1	B	11
Off	On	On	Off	Off	0	1	1	0	0	C	12
Off	On	On	Off	On	0	1	1	0	1	D	13
Off	On	On	On	Off	0	1	1	1	0	E	14
Off	On	On	On	On	0	1	1	1	1	F	15
On	Off	Off	Off	Off	1	0	0	0	0	10	16
On	Off	Off	Off	On	1	0	0	0	1	11	17
On	Off	Off	On	Off	1	0	0	1	0	12	18
On	Off	Off	On	On	1	0	0	1	1	13	19
On	Off	On	Off	Off	1	0	1	0	0	14	20
On	Off	On	Off	On	1	0	1	0	1	15	21
On	Off	On	On	Off	1	0	1	1	0	16	22
On	Off	On	On	On	1	0	1	1	1	17	23
On	On	Off	Off	Off	1	1	0	0	0	18	24
On	On	Off	Off	On	1	1	0	0	1	19	25
On	On	Off	On	Off	1	1	0	1	0	1A	26
On	On	Off	On	On	1	1	0	1	1	1B	27
On	On	On	Off	Off	1	1	1	0	0	1C	28
On	On	On	Off	On	1	1	1	0	1	1D	29
On	On	On	On	Off	1	1	1	1	0	1E	30
On	On	On	On	On	1	1	1	1	1	1F	31

On = pins connected.

Off = pins left open.



Programmable 8 Ch I R Remote Control Relay Board - iR-8R-V

User manual

Command bits are grouped for 8 relays and four such groups can be set with the help of jumper J3 settings as shown below -

Relay	Jumper J3 settings							
	Group 1		Group 2		Group 3		Group 4	
	Pins 3&4	Pins 1&2	Pins 3&4	Pins 1&2	Pins 3&4	Pins 1&2	Pins 3&4	Pins 1&2
	Off	Off	Off	On	On	Off	On	On
Relay1	0 or 00h		14 or 0Eh		28 or 1Ch		42 or 2Ah	
Relay2	1 or 01h		15 or 0Fh		29 or 1Dh		43 or 2Bh	
Relay3	2 or 02h		16 or 10h		30 or 1Eh		44 or 2Ch	
Relay4	3 or 03h		17 or 11h		31 or 1Fh		45 or 2Dh	
Relay5	4 or 04h		18 or 12h		32 or 20h		46 or 2Eh	
Relay6	5 or 05h		19 or 13h		33 or 21h		47 or 2Fh	
Relay7	6 or 06h		20 or 14h		34 or 22h		48 or 30h	
Relay8	7 or 07h		21 or 15h		35 or 23h		49 or 31h	
All ON	12 or 0Ch		26 or 1Ah		40 or 28h		54 or 36h	
All OFF	13 or 0Dh		27 or 1Bh		41 or 29h		55 or 37h	

Mode setting -

Relay	Jumper J2 settings							
	Pins 3&4	Pins 1&2	Pins 3&4	Pins 1&2	Pins 3&4	Pins 1&2	Pins 3&4	Pins 1&2
	Off	Off	On	Off	On	Off	On	On
Toggle	1 to 8		3 to 8		5 to 8		7 to 8	
Momentary	-		1 to 2		1 to 4		1 to 6	

The default settings of the card is all the jumpers are in Off position. Thus the System & Command bits will be 0. For Command bits, group 1 will be selected. As far as Mode is concerned, all the Relays will be in Toggle mode.

The Remote Handset (to be purchased separately) is having the system code 0 and its 0 to 7 number buttons are having Group 1 codes so it can be used for operating the board in its default setting.

Also as each card is having its unique All On & All Off codes, all relays of any card can be made On or Off without affecting any other card.

Dimensions of the board

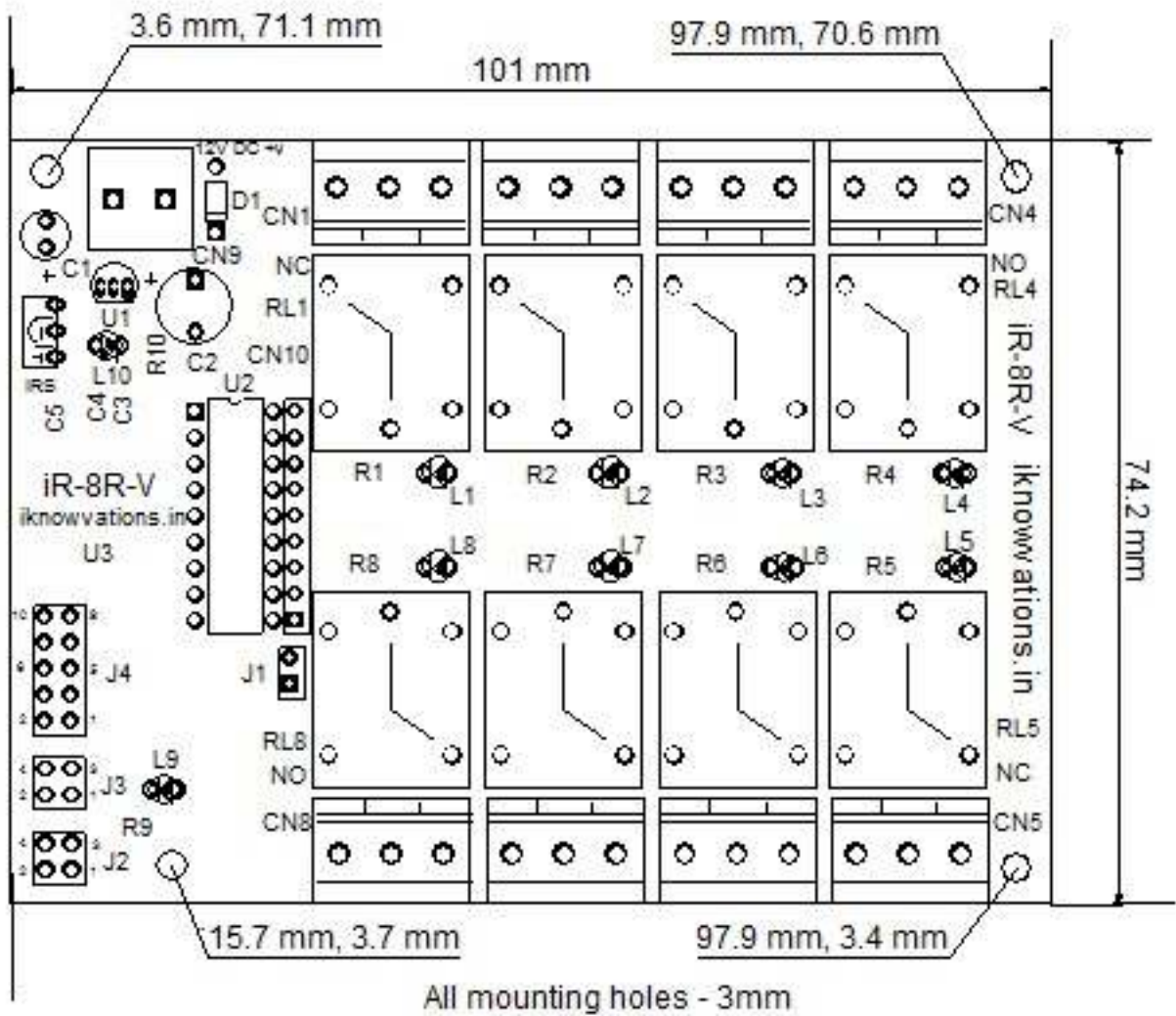

How to make Remote light switches using IR control relay boards iR-8R-V

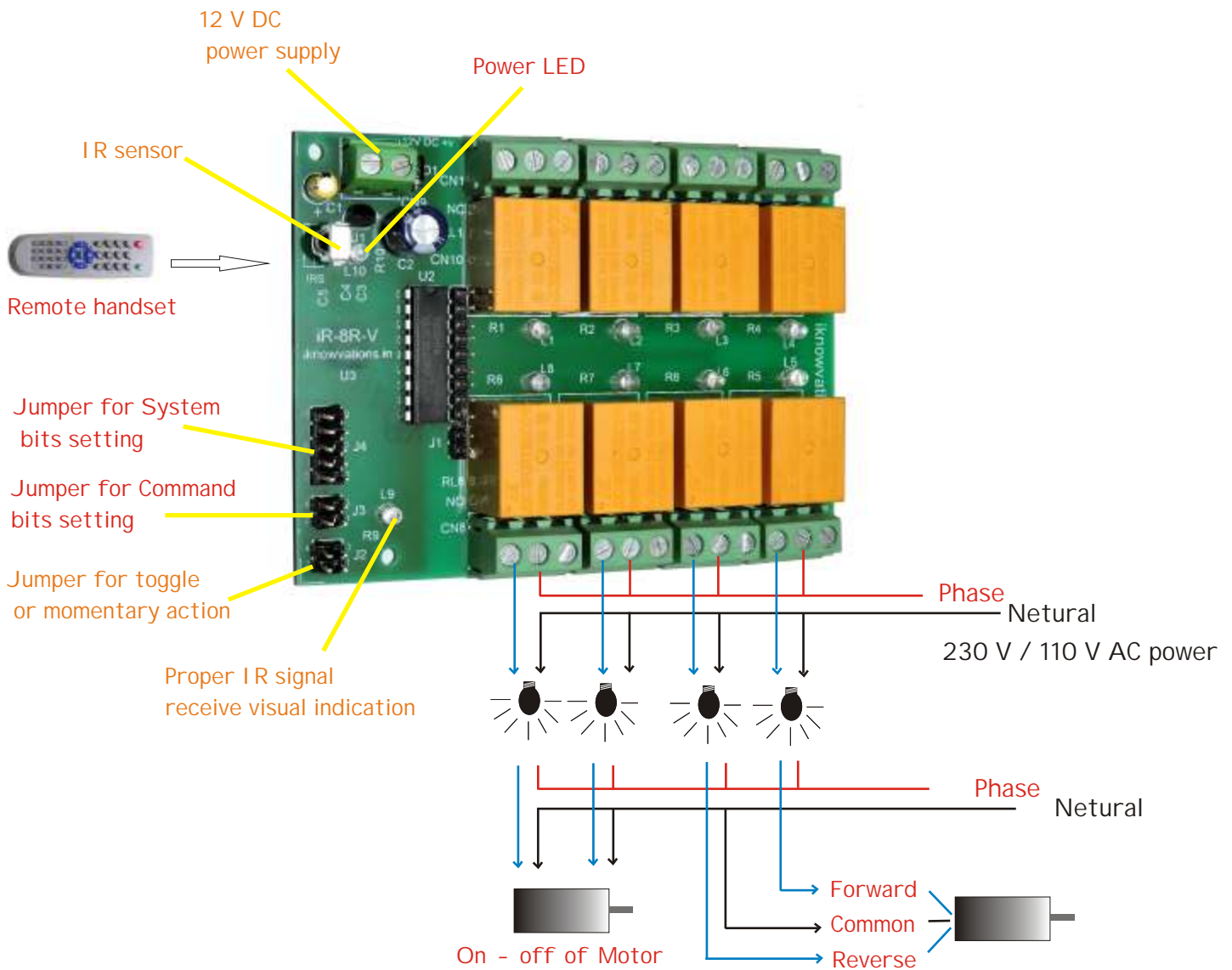

For Motor on/off & forward/reverse, use momentary function



Programmable 8 Ch I R Remote Control Relay Board - iR-8R-V

User manual

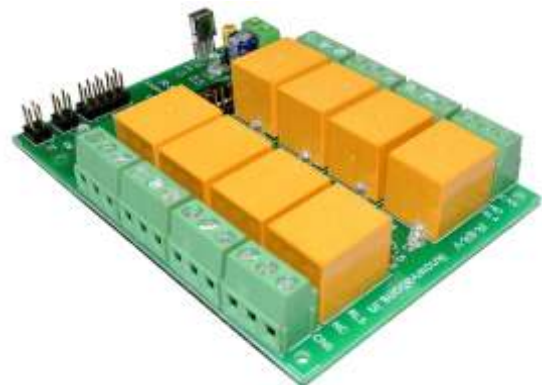

If you have any questions, want any assistance, want us to develop any special products for you just contact us at support@iknowvations.in.

We have other products also that might interest you like -



4 channel I R Remote control Board - AZ4CR-03

6 channel I R Remote control Board - AZ6CR-03



U452 is an USB based Relay Card having 4 relays, up to 16 I/O channels & 8 ADC channels. The ADC resolution is 8/10/12 bits user selectable.

R242 is an RS232 based Relay Card having 4 relays, up to 9 I/O channels & 4 ADC channels. The ADC resolution is 10 bits.



Ethernet based DAQ & I/O card.

6 digit 7 segment Multipurpose LED Counter



For more information visit - www.iknowvations.in



Programmable 8 Ch I R Remote Control Relay Board - iR-8R-V

User manual

Please Read Carefully

Information in this document is provided solely in connection with I knowvations products. I knowvations reserve the right to make changes, corrections, modifications or improvements, to this document, and the products and services described herein at anytime, without notice.

All I knowvations products are sold pursuant to I knowvations terms and conditions of sale.

Purchasers are solely responsible for the choice, selection and use of the I knowvations products and services described herein, and I knowvations assumes no liability whatsoever relating to the choice, selection or use of the I knowvations products and services described herein.

No license, express or implied, by estoppel or otherwise, to any intellectual property rights is granted under this document. If any part of this document refers to any third party products or services it shall not be deemed a license grant by I knowvations for the use of such third party products or services, or any intellectual property contained therein or considered as a warranty covering the use in any manner whatsoever of such third party products or services or any intellectual property contained therein.

UNLESS OTHERWISE SET FORTH IN I KNOWVATIONS'S TERMS AND CONDITIONS OF SALE I KNOWVATIONS DISCLAIMS ANY EXPRESS OR IMPLIED WARRANTY WITH RESPECT TO THE USE AND/OR SALE OF I KNOWVATIONS PRODUCTS INCLUDING WITHOUT LIMITATION IMPLIED WARRANTIES OF MERCHANTABILITY, FITNESS FOR A PARTICULAR PURPOSE (AND THEIR EQUIVALENTS UNDER THE LAWS OF ANY JURISDICTION), OR INFRINGEMENT OF ANY PATENT, COPYRIGHT OR OTHER INTELLECTUAL PROPERTY RIGHT.

UNLESS EXPRESSLY APPROVED IN WRITING I KNOWVATIONS PRODUCTS ARE NOT RECOMMENDED, AUTHORIZED OR WARRANTED FOR USE IN MILITARY, AIR CRAFT, SPACE, LIFE SAVING, OR LIFE SUSTAINING APPLICATIONS, NOR IN PRODUCTS OR SYSTEMS WHERE FAILURE OR MALFUNCTION MAY RESULT IN PERSONAL INJURY, DEATH, OR SEVERE PROPERTY OR ENVIRONMENTAL DAMAGE.

Resale of I KNOWVATIONS products with provisions different from the statements and/or technical features set forth in this document shall immediately void any warranty granted by I knowvations for the I knowvations product or service described herein and shall not create or extend in any manner whatsoever, any liability of I knowvations.

www.iknowvations.in

Manufactured by -

I knowvations
Rajivnagar, Vidyanagar
Hubli - 580031
India.

Contacts -

Web - iknowvations.in
Sales - sales@iknowvations.in
Support - support@iknowvations.in
Information - info@iknowvations.in

Buy online at our Shoppee -

<http://shoppee.iknowvations.in>